

CIRCUIT: SPST

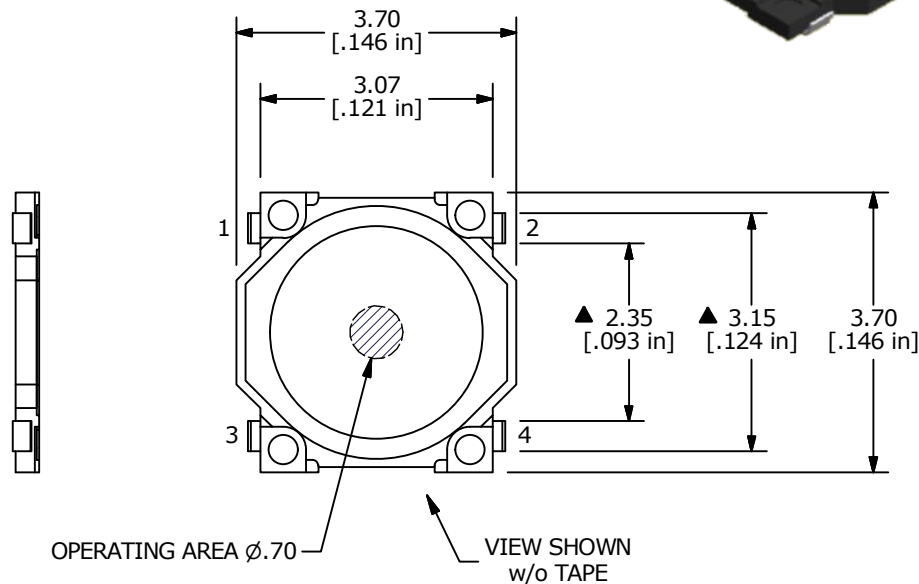

NOTE:

1. ALL DIMENSIONS IN MM [INCH]
2. GENERAL TOLERANCE: X.X = ±0.4  
X.XX = ±0.25
3. TERMINAL NUMBERS FOR REF ONLY
4. CONTACT RATING: 12VDC @ 50mA
5. OPERATING LIFE: 50,000 CYCLES
6. CONTACT RESISTANCE: 100m OHMS MAX.
- ▲ 7. OPERATION FORCE: 235 +/-60gf
8. TRAVEL: 0.15mm
9. OPERATING/STORAGE TEMP.: -40°C to +85°C
9. ▲ DENOTES CRITICAL PARAMETER.
10. HALOGEN FREE
11. 2011/65/EU (ROHS) COMPLIANT
12. PACKAGING: TAPE & REEL 8000 PIECES PER REEL

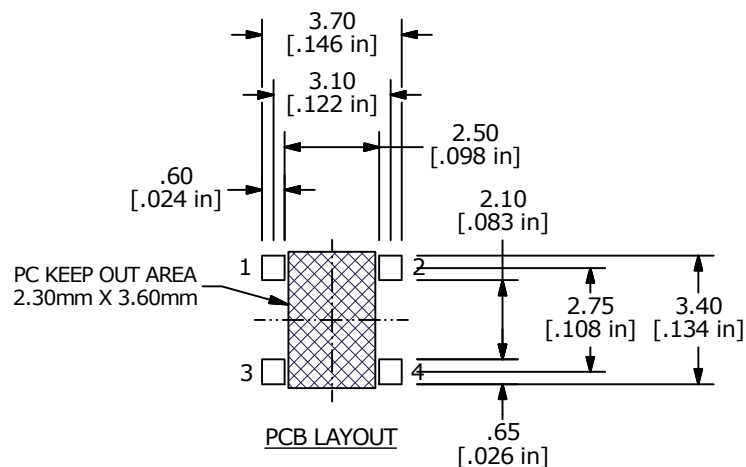

A	23397	New Product Release	6/7/18	MW
REV	PCR NO	DESCRIPTION	DATE	BY

TITLE TL3312NF235Q				
SCALE	DATE	DR	DWG	REV
10:1	6/7/2018	MW	N301202	A

THE INFORMATION CONTAINED IN THIS DOCUMENT IS PROPRIETARY TO E-SWITCH AND IS NOT TO BE COPIED OR TRANSFERRED